

# Motor part

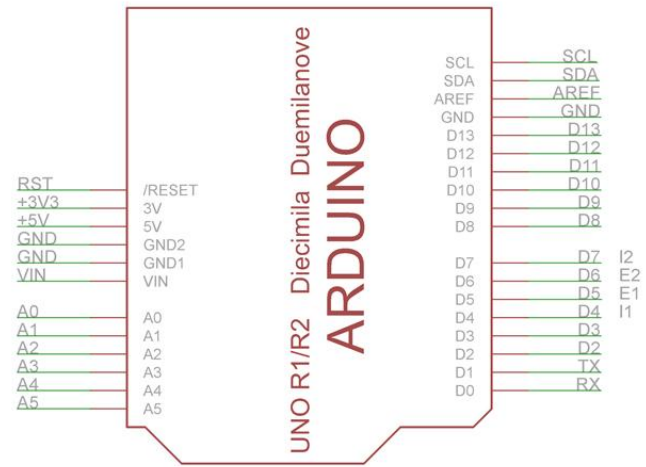

# Sensor Shield

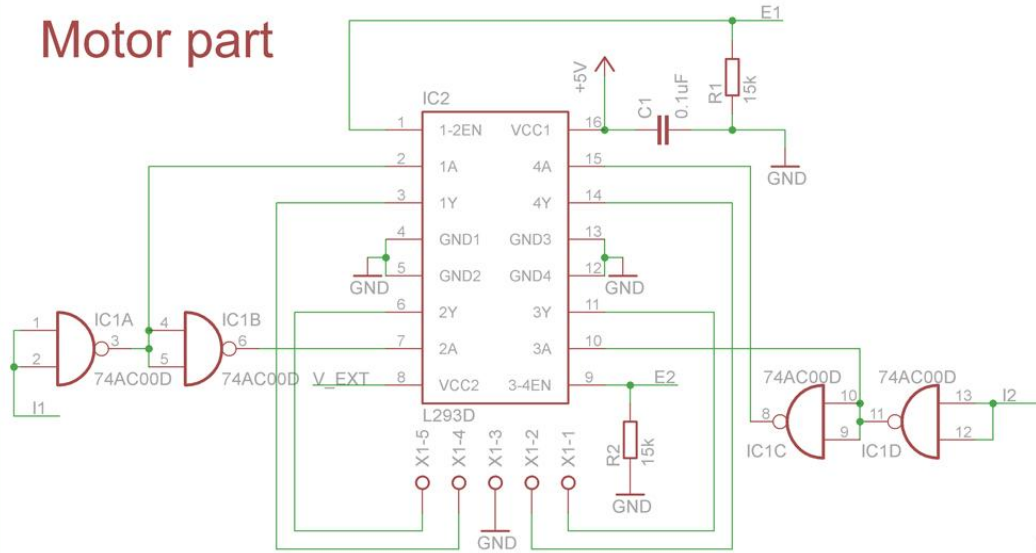
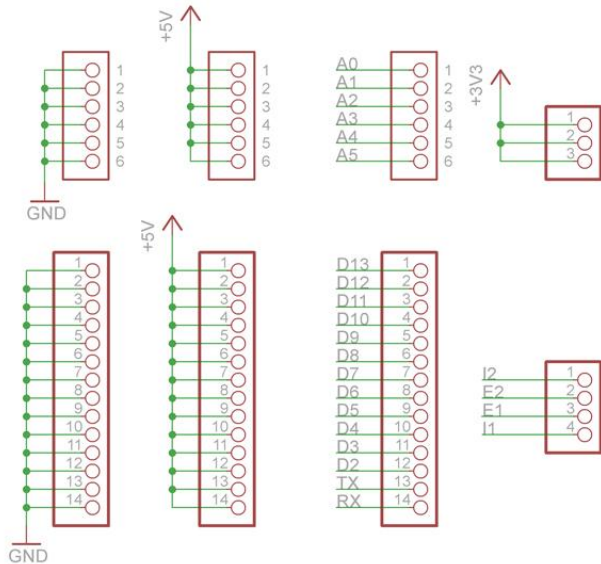

# Power select jumper



# Voltage regulator

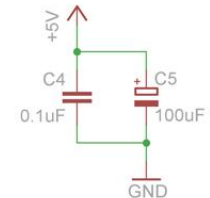
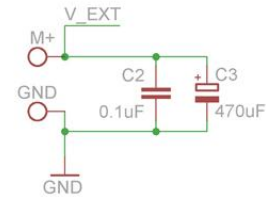

# Power led

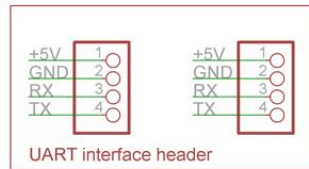
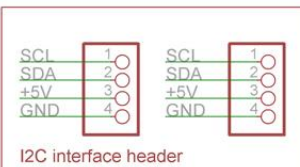
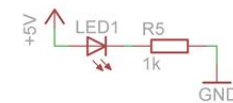

TITLE: Z-Motor + Sensor Shield L293D

Document Number:

REV:1

Date: 19.09.2015 19:05:20

Sheet: 1/1